

CAUTION—ELECTRICALLY OPERATED PRODUCT (TRANSFORMER)

RATING: INPUT: 120 VAC, 60 Hz. OUTPUT: 20 VAC, 14 VA

Not recommended for children under eight years of age. As with all electrical products, precautions should be observed during handling and use to prevent electric shock. Parents please note: It is recommended that this robot be periodically examined for any potential hazards and that any potentially hazardous parts be repaired or replaced.

ELECTRONIC MAXX[®] STEELE[®] PERSONAL ROBOT

USER'S GUIDE TO OPERATIONS



IDEAL[®]

**ELECTRONIC MAXX STEELE®
PERSONAL ROBOT**

USER'S GUIDE TO OPERATIONS

FRONT VIEW

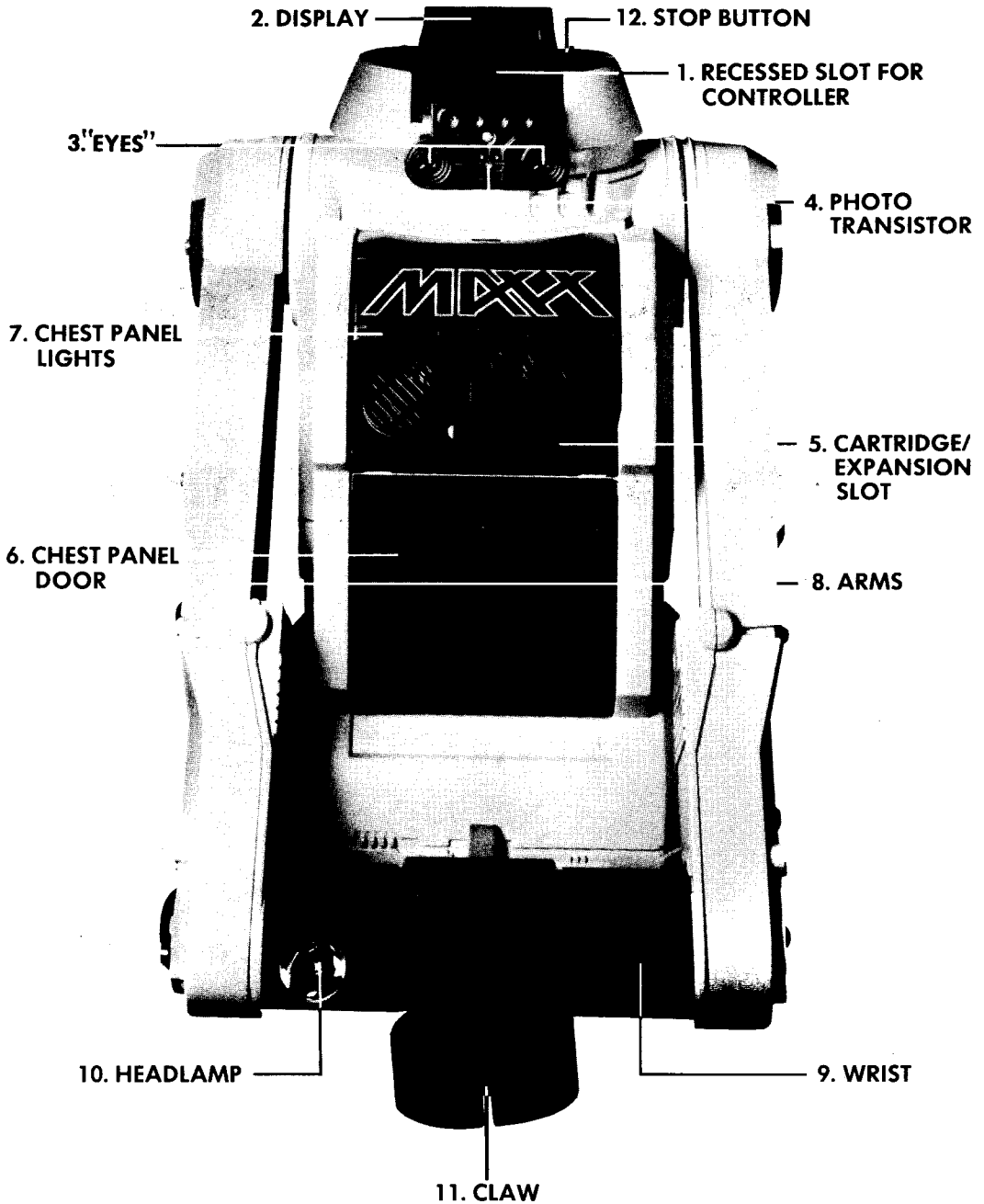

REAR VIEW

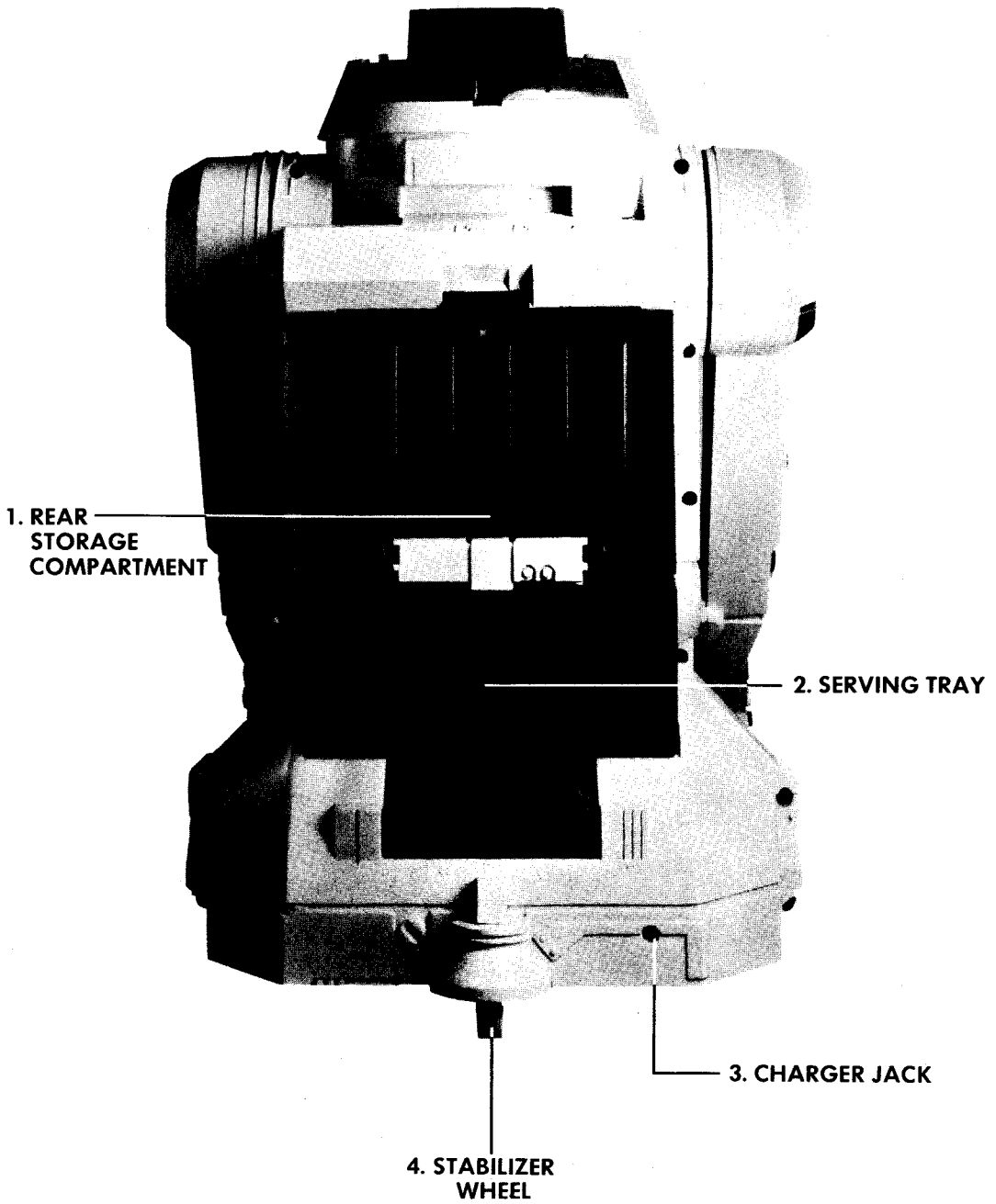

NOTE: Prior knowledge of computers or robotics is not necessary to operate Maxx®.

This Guide to Operations Introduces you to the Electronic Maxx Steele® Personal Robot. The manual has five sections. A table of contents is included at the back of this manual.

Section 1, Introduction, is a guide to getting to know your friendly personal robot, Maxx Steele®.

Section 2, Setup, shows you how to get Maxx ready for use.

Section 3, Operations, introduces you to the things Maxx can do, shows you how to operate the controller, and provides a summary of commands and functions.

Section 4, Modes, shows you how to enter commands in any one of the five operating modes (The Immediate Mode, The Program Mode, The Execute Mode, The Learn Mode and The Game-Playing Mode).

Section 5, Advanced Features, shows you how to perform more sophisticated programming and editing operations.

The Appendices include: information on the technical aspects of Maxx, a glossary of terms, pre-programmed songs, pre-programmed phrases, speech codes, a glossary of prompts, routine maintenance, operating conditions, cautions, a summary of controller functions and special keys, and a table of contents.

1. INTRODUCTION

This is a guide for the care, programming and enjoyment of Maxx Steele®, your personal robot. It outlines the things you need to do to become familiar with Maxx and his many features.

In general, here is how Maxx works. He is operated and programmed by a wireless remote controller that communicates with a computer "brain" housed in his upper body. His brain controls and coordinates all of Maxx's "mental" functions, such as memory, speech, music, time and game play. In addition, it operates the "physical" functions of the motors in his arms, wrist, claw and wheels.

Maxx's built-in computer features an 8 K ROM operating system and a 2 K RAM computer memory, expandable to 63 K total.

His programmable memory and "learn" mode enable you to program a sequence of actions and activities which Maxx will then perform again and again—by himself, from memory!

2. SETUP

NOTE: Save the shipping carton and foam inserts. They should be kept if you ever need to transport Maxx or send him to us for any repairs (see separate Warranty). **IMPORTANT:** See separate sheet for instructions on installing STABILIZERS and other first-time use information.

2.1 UNPACKING

Carefully remove Maxx, packed in foam shipping shells, from his box. Then carefully spread apart the shells.

NOTE: Always lift Maxx by his shoulders. **DO NOT LIFT HIM BY HIS ARMS AS THIS MIGHT DAMAGE THE ARMS.**

2.2 ACTIVATING MAXX'S POWER

Maxx's POWER SWITCH is located inside his chest storage compartment in the lower left corner. This controls all Maxx's electronics, including the clock and memory.

To Turn On The Power Switch:

1. Remove TAPE from POWER SWITCH.
2. Put the POWER SWITCH UP into the ON position. Maxx will respond by saying, "Hello. I am Maxx Steele. [TUNE PLAYS] I'm ready."
3. If Maxx does not respond in exactly this way, shut off the POWER SWITCH, wait 2 seconds, and turn it on again.

4. Close CHEST PANEL DOOR and push the button up to latch.

NOTE: Turning this switch off will result in the loss of anything you may have programmed.

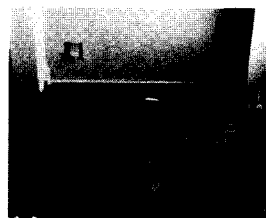

POWER SWITCH

Charge Maxx fully before his first use. When he needs a charge, he will ask for it by saying, "I need energy. Please recharge me." (Refer to LABEL inside his CHEST COMPARTMENT DOOR.) Maxx's CHARGER comes packed in a recessed pocket of the foam shell he was shipped in. **NOTE:** Maxx should be recharged with the POWER SWITCH in the OFF position; however, any program stored in his memory will be erased. Maxx can be charged with POWER SWITCH ON, but he should first be placed in the Power-Down or "Sleep" Mode (see Sections 5.3, 5.31 and 5.32).

•To Charge Maxx:

1. Insert CHARGER OUTPUT PLUG into CHARGER JACK located at the bottom right rear of Maxx.
2. Plug CHARGER WALL PLUG into a standard wall out.
3. Once charged, disconnect jack and wall plug.
4. Maxx's battery cannot be overcharged. Charge Maxx whenever he is not in use. Under normal circumstances, an overnight charge every night will be sufficient.

NOTE: Do not engage Maxx's MOTION functions while he is charging. Sudden movement may disconnect or damage the charger plug and jack.

IMPORTANT: WHEN MAXX NEEDS A CHARGE, HE WILL ASK FOR IT. NEVER IGNORE HIS REQUEST FOR A CHARGE, OR HE MAY REQUIRE UP TO A WEEK OF CONTINUOUS CHARGING TO RESTORE SUFFICIENT BATTERY POWER FOR OPERATION.

2.3 CHARGING MAXX

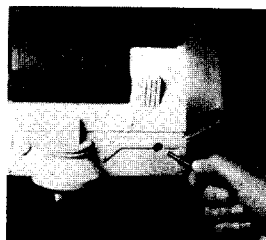

CHARGER

Maxx's controller is used as a remote control keypad. It is also used to program a sequence of actions for Maxx to perform, now or later. The information listed below shows you how to use the controller to enter commands you want Maxx to perform. (see APPENDIX J. SUMMARY OF CONTROLLER FUNCTIONS AND SPECIAL KEYS for more detailed information.)

2.4 THE CONTROLLER



Key 0: Drive Left
Musical Note C

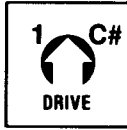

Key 1: Drive Forward
Musical Note C#

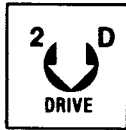

Key 2: Drive Reverse
Musical Note D

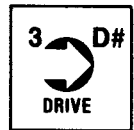

Key 3: Drive Right
Musical Note D#



Key 4: Wrist Up
Musical Note E

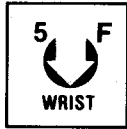

Key 5: Wrist Down
Musical Note F



Key 6: Arms Up
Musical Note F#



Key 7: Arms Down
Musical Note G



Key 8: Claw Rotate
Musical Note G#



Key 9: Claw Close or
Open/Musical Note A

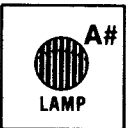

Lamp On or Off
Musical Note A#

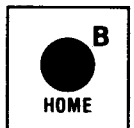

Home
Musical Note B

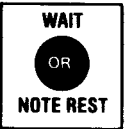

Wait
or Note Rest



Shift Octave



Clear

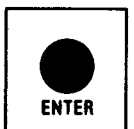

Enter



Song or Notes



Clock or Status

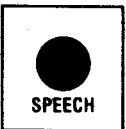

Speech

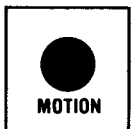

Back Step



Game



Program



Learn

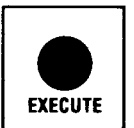

Execute

POWER/STOP



Keybar: Power/Stop

Remove the controller from the upper rear STORAGE COMPARTMENT located in Maxx's back. Unwrap the controller, insert a small coin into the notch at the bottom of the battery cover on the back of the controller and snap out the BATTERY DOOR. Install a fresh 9-volt alkaline battery (not included) as shown.

IMPORTANT: Observe battery polarity.

Snap the BATTERY DOOR back into place. Pull up antenna. To activate the controller, press the <POWER/STOP> key. An LED POWER INDICATOR, located in the upper right corner of the front of the controller, will go on. The controller will shut off a short time after the last keystroke if no other buttons are pressed.

NOTE: When the controller shuts down automatically, no program information will be lost, as long as Maxx's main POWER SWITCH has remained on. Press the <POWER/STOP> key once to reactivate the controller.

NOTE: If the controller fails to shut off automatically, remove and re-install the battery. If the problem persists, the battery should be replaced with a fresh alkaline cell.

NOTE: See **APPENDIX I. CAUTIONS.**

• Here are Several Things Maxx Can Do:

1. Press the <POWER/STOP> key. This tells Maxx that you are ready.
2. After Maxx says "I'm ready," press and hold each of the following keys one at a time:

<DRIVE LEFT> to turn to Maxx's left

<DRIVE FORWARD> to move ahead

<DRIVE BACKWARD> to move back

<DRIVE RIGHT> to turn to Maxx's right

<WRIST UP> to move the wrist up

<WRIST DOWN> to move the wrist down

<ARMS UP> to move the arms up

<ARMS DOWN> to move the arms down

<CLAW ROTATE> to turn the claw

<CLAW CLOSE/OPEN> to open and close the claw

<LAMP ON/OFF> to turn the lamp on and off

<HOME> to have Maxx reset his arms, wrist and claw to their initial, or home, positions.

3. Press the <SONG> key twice. When Maxx's display shows "notE", press any of the first twelve keys, corresponding to musical notes from C to B, on the top of the controller. This will give you an idea of how to play a tune. Press <POWER/STOP> to end the music session.

4. Press the <SPEECH> key. When "SS__" appears in Maxx's display, press the <2> key, the <1> key and the <ENTER> key. Maxx will respond by asking "Is there anything I can do for you?"

5. Now press the <SPEECH> key twice. When "S__" appears in Maxx's display, press the <6> key, the <5> key and then the <ENTER> key. Maxx will respond by saying "Hello," word number 65 from the Speech Code listed in Appendix E. Press <POWER/STOP> to end the speech session.

6. Press the <GAME> key. Maxx will play his Game Mode tune and say "Please choose game." Turn to section 4.5 GAME PLAYING-MODE, read the instructions for the games, choose a game, and enjoy!

IMPORTANT: Maxx must do the following before he is ready to operate: say "Hello. I am Maxx Steele," play his "Immediate Mode tune" and then say "I'm ready." If he does not do these things in the sequence described, shut off Maxx's POWER SWITCH, wait 2 seconds, and turn it on again.

3. STARTING MAXX



STORAGE COMPARTMENT



BATTERY DOOR



LED POWER INDICATOR

•How to Start A Session With Maxx:

1. Take controller and pull out antenna.
2. Press the <POWER/STOP> key. The LED light on the controller will turn on, indicating that the controller is active.

NOTE: The controller will shut off a short time after the last keystroke if no other buttons are pressed. To reactivate the controller, press the <POWER/STOP> key.

3. Make sure that Maxx's POWER SWITCH, located inside his chest storage compartment in the lower left corner, is UP in the ON position.

4. Press the <POWER/STOP> key again. Maxx will respond by playing the Immediate Mode tune and say "I'm ready." This puts Maxx in the Immediate Mode. In this mode, Maxx will "immediately" perform each action you choose. Pressing the keys on the controller will select the specific action you want performed.

5. If you want to choose a different operating mode: press the <SONG> key to play music, the <SPEECH> key to have Maxx speak words or phrases, the <GAME> key to play games, the <PROGRAM> key to program a series of actions, or the <LEARN> key to "teach" Maxx. All of these modes and functions are explained later in this manual.

6. Upon completion of your session with Maxx, press the <HOME> key, lower the antenna on the controller and return it to the recessed compartment on the top of his head. Maxx will automatically shut off (Power-Down) after approximately 13 minutes.

NOTE: Maxx can be set to Power-Down manually, if you do not want to wait 13 minutes before he goes into his Auto Power-Down procedure (see 5.32 Manual Power-Down).

4. MODES OF OPERATION

Maxx has five major operating modes. They are: the Immediate Mode (see section 4.1), the Program Mode (see 4.2), the Learn Mode (see 4.3), the Execute Mode (see 4.4), and the Game-Playing Mode (see 4.5).

4.1 IMMEDIATE MODE

When the controller is turned on, by pressing the <POWER/STOP> key, you are in the Immediate Mode. Maxx will play his Immediate Mode tune and say "I'm ready." Pressing other keys after that will select the specific action you want performed, such as setting the time, the alarm, auto-execution features, making Maxx move, speak and play music. Maxx will immediately perform each action as you press the keys.

4.1.1 TIME

Built into Maxx is a LED digital clock/alarm. He can wake you up, activate himself to run your programs at a preset time, or remind you of things to do.

4.1.1A SETTING THE TIME

Setting the time is an operation that you may want to do the first time Maxx is switched on. Once set, the clock will stay accurate until the battery runs down or the POWER SWITCH is turned OFF. The clock has a 12-hour display. The decimal point (.) located in the upper left of Maxx's display indicates PM when lit.

NOTE: Each of the following functions is performed in the Immediate Mode, after Maxx says "I'm ready."

•To Set The Clock:

1. Press the <CLOCK> key. Maxx's display will show "CLoC", indicating that he expects the clock to be set.
2. To advance the hours, press the <0> key and hold down. Release the

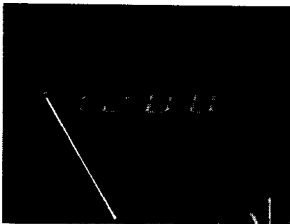

PM INDICATOR

button when the correct hour appears in Maxx's display.

3. To advance the minutes, press <1> key and hold down. Release the button when the correct minutes appear in Maxx's display.

4. When the clock has been set, the colon (:) between the hours and minutes digits will blink every second.

NOTE: Once you have finished setting the clock, you must press the <POWER/STOP> key or another function key [<SONG> or <SPEECH>] to exit the Time Mode. When you press the last key, the time will go into Maxx's memory. He will continue keeping the time until a new setting is entered, or until his batteries run down or the POWER SWITCH is turned OFF.



• *To Set The Alarm:*

1. Press the <CLOCK> key. Maxx's display will show "CLoC", indicating that he expects the alarm to be set.

2. To advance the alarm hours, press the <2> key and hold down. Release the button when the correct hour appears in Maxx's display.

3. To advance the alarm minutes, press the <3> key and hold down. Release the button when the correct minutes appear in Maxx's display.

4. The decimal point (.) located in the lower left of Maxx's display indicates that the alarm is on when lit.

5. To turn on or off the alarm you have set, press the <CLOCK> key (if you are not already in the Clock Mode) and then press the <6> key. The LED ALARM INDICATOR will go on or off, indicating that the alarm is on or off.

6. Maxx can be programmed to automatically execute a program when the alarm goes off (see 5.1 AUTO—EXECUTE).

7. To simply display the alarm time, press the <CLOCK> key (if you are not already in the Clock Mode) and then press the <5> key.

8. If you want the alarm to go off again, 24 hours later, you must turn it on again, by pressing the <6> key. The alarm time need not be re-entered unless you wish to change it.

NOTE: Once you have finished setting the alarm, you must press the <POWER/STOP> key or another function key [SONG or SPEECH] to exit the time mode.

• *Summary Of Clock And Alarm Features:*

1. When in the Immediate Mode, press the <CLOCK> key. Maxx's display will show "CLoC".

2. When Maxx's display shows "CLoC" and you want to know the time displayed, press the <4> key.

3. A decimal point located in the upper left of Maxx's display will indicate PM when lit.

4. When Maxx's display shows "CLoC" and you want to know the alarm time displayed, press the <5> key.

5. To turn the alarm on or off, press the <6> key.

6. A decimal point (.) located in the lower left of Maxx's display will indicate that the alarm is on when lit.

7. The time or alarm need not be reset unless desired or if the battery is allowed to run down.

8. If power is interrupted, Maxx's display will blink "12:00".

NOTE: Make sure that Maxx is moving around in a clear area, free from hazards or obstacles. Practice the motion commands carefully until you are familiar with varying speed and changing directions. Be especially careful if Maxx may encounter uneven surfaces.

NOTE: All functions that follow are entered in the Immediate Mode.

4.11B SETTING THE ALARM

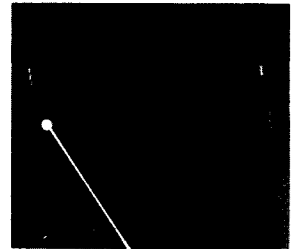

4.12 MOTION

4.12A MOVING ARMS, WRIST AND CLAW

Pressing the <ARMS UP> key will raise Maxx's arms until the key is released. Other keys will work in a similar way, including the <ARMS DOWN>, <WRIST UP>, <WRIST DOWN>, and <CLAW ROTATE> keys.

NOTE: The wrist automatically moves in the opposite direction of arm motion. This way the claw automatically stays level as the arm is moved (assuming the claw is level to begin with). The <CLAW CLOSE/OPEN> key controls the claw. When the <CLAW CLOSE/OPEN> key is pressed, if the claw is closed, it will open, and vice versa. There are no intermediate open or closed positions for the claw.

NOTE: The claw will fully close before it will open again, and vice versa. In other words, to release an object, the claw must be cycled through the point at which it is completely closed or open. Therefore, the object held in the claw must be able to withstand the grasping force applied at that point. Do not place fragile items in Maxx's claw. After cycling through complete closure, the force of the claw will be reduced until it releases the object. Examples of things Maxx can pick up without crushing include a tennis ball, a soda can and a hard-boiled egg. Things Maxx may crush include an uncooked egg and a potato chip.

4.12B MOVING FORWARD AND BACKWARD

NOTE: When operating in the Immediate Mode, Maxx has two forward and two reverse speeds.

Starting With Maxx Standing Still:

1. When you press the <FORWARD> key, Maxx will start moving forward at his low speed.
2. Correspondingly, when Maxx is standing still and you press the <REVERSE> key, he will start moving backward at his low speed.
3. If you continue to hold the key down, he will speed up, shifting into his high speed after one second.
4. When the <FORWARD> or <REVERSE> key is released, Maxx will stop.
5. If you want to control the rate of movement and fine-position Maxx, use short key depressions (i.e., stopping and starting the movement). This will prevent Maxx from shifting into high speed.

4.12C TURNING

•*To Turn Maxx's Body:*

1. Press the <FORWARD> or <REVERSE> key to indicate the direction of movement.
2. Then press the <TURN LEFT> or <TURN RIGHT> key.
3. Maxx turns by starting the left or right wheel, as chosen.
4. As with forward and backward motion, if you continue to hold the key down, Maxx will speed up the rate at which he turns, shifting to the high speed after one second.
5. When the <TURN LEFT> or <TURN RIGHT> key is released, Maxx will stop.
6. If you want to control the rate of movement and fine-position Maxx, use short key depressions (i.e., stopping and starting the movement). This will prevent Maxx from shifting into high speed.

NOTE: Whenever Maxx is turning right or left, *he turns to his right or left.* In other words, while he is moving toward you, he will appear to turn in the opposite direction from the arrows on the controller.

4.13 SPEECH

Maxx speaks over 140 words and word particles, which can be combined into many additional words. In addition, you can program a phrase by entering the pre-programmed individual words and he'll recite them from memory (see APPENDIX F. SPEECH CODES).

16 places, numbered 0 through 15, have been reserved in Maxx's memory for you to program your own phrases (see 4.63 Program Speech Mode). In addition, Maxx can speak 17 pre-programmed phrases, numbered 16 to 32.

• *To Get Maxx To Speak Phrases:*

1. Press the <SPEECH> key and hold for approx. 1 second.
2. The display will read "SEnt" for a short time, then "SS__"
3. This is a PROMPT for you to enter a number (16 to 32) specifying which phrase should be spoken.
4. After the number keys for the phrase are pressed, press the <ENTER> key. Maxx will speak the phrase.

For example, after PROMPT "SS__" appears, if you press key <2>, key <0> and then the <ENTER> key, Maxx will say "Thank you" (pre-programmed phrase number twenty). After speaking the phrase, Maxx will return to the Immediate Mode. If another phrase is desired, press the <SPEECH> key and proceed as before.

A list of Maxx's pre-programmed phrases can be found in APPENDIX D. PRE-PROGRAMMED PHRASES.

**PRE-
4.13A PROGRAMMED
PHRASES**



PROMPT FOR
PRE-PROGRAMMED
PHRASES

Maxx can also speak individual words.

• *To Get Maxx To Speak Words:*

1. Press the <SPEECH> key TWICE and hold for approx. 1 second.
2. The display will read "SPEE" for a short time, then "S___." This is a PROMPT for a word number or numbers, from 0 to 140, from the Speech Code listed in Appendix E.
3. After the number keys are pressed, press the <ENTER> key. Maxx will respond by saying the selected word.

For example, if you want Maxx to say "hello," press the <6> key, the <5> key and then the <ENTER> key. Maxx will respond by saying "hello" (word 65 from APPENDIX F. SPEECH CODES).

**PRE-
4.13B PROGRAMMED
WORDS**



PROMPT FOR
SPEECH CODE

Maxx's controller can be used to play music in the Immediate Mode. In addition, you can teach him a song and he'll perform it from memory (see 4.62 Learn Song Mode). Or, press a few buttons and let him run through his own pre-programmed repertoire.

4.14 MUSIC

Song number 0 is a blank place for you to program your own song (see 4.61 Program Song Mode and 4.62 Learn Song Mode). If no song has been entered, playing song number 0 will do nothing.

NOTE: Maxx will retain your programmed song until you clear it or until his POWER SWITCH is turned off. Write down any song you wish to save.

In addition, Maxx can play eight pre-programmed songs, numbered 1 to 8. A list of pre-programmed songs can be found in APPENDIX C. PRE-PROGRAMMED SONGS.

**PRE-
4.14A PROGRAMMED
SONG**



PROMPT FOR
PRE-PROGRAMMED SONG

• *To Play A Pre-Programmed Song:*

1. Press the <SONG> key and hold for approx. 1 second. Maxx's display will show "Song" for a short time.
2. Then Maxx's display will show "Sn__". This is a PROMPT for you to enter a number from 1 to 8 to specify which of eight songs should be played.

3. After the number key is pressed, press the <ENTER> key. Maxx will play the song.

For example, after PROMPT "Sn _" appears, if you press key <1> then the <ENTER> key, Maxx will play song number one. After playing a song, Maxx will return to the Immediate Mode. If another song is desired, push the <SONG> key and proceed as before.

4.14B USING THE CONTROLLER AS A MUSICAL INSTRUMENT



NOTE-PLAYING MODE

Maxx's controller also functions as a "keyboard" instrument.

To Play Music:

1. Press the <SONG> key TWICE.
2. The display will read "note" (Fig.), indicating that you are in the Note-Playing Mode.
3. Press the keys corresponding to the notes you want to play.
4. Press the <POWER/STOP> key to exit the Note-Playing Mode (see 4.61 Program Song Mode and 4.62 Learn Song Mode).

4.14C OCTAVE SHIFT

The music Maxx can play has a two-octave range; but since there is only one set of keys, a shift key is provided.

•To Shift Octaves:

1. Press the <OCTAVE> key before the note key is pressed.
2. Each time the <OCTAVE> key is pressed, the octave switches up or down; therefore, if you raised the octave for the previous note and you want to return to the lower octave, you must press the <OCTAVE> key again to lower the octave before pressing the next note key.

4.2 PROGRAM MODE

NOTE: When in the Program Mode, pressing the <HOME> key and the <ENTER> key causes Maxx to move to his initial starting position when the program is executed. Doing this is important because it gives Maxx a specific starting point from which to begin any operation. Without an initial or home position, Maxx would not "know" what position his arms, wrist and claw are in. You may want Maxx to execute each program from the home position.

•When You Initialize Maxx by Pressing the <HOME> Key, the Following Will Take Place:

1. The WRIST will rotate up fully to its limit, which is parallel to his arms, and the claw will rotate to the starting position.
2. The ARMS will move down, coming to within 2" of his body, and the CLAW will fully close.

•Entering The Program Mode

Pressing the <PROGRAM> key puts Maxx in the Program Mode. Maxx will play his Program Mode tune and say "Please program me." As with a personal computer, you enter commands, step-by-step, in the sequence you want Maxx to perform them. Each step is entered one at a time. Maxx waits until you press <ENTER> to complete and store each program step. The display will then show the number of the next step. He waits until you are finished and then runs the program when you press the <EXECUTE> key. Maxx will momentarily buzz if an error is made.

NOTE: When in the Program or Learn Mode, the program currently in Maxx's memory will be cleared when you enter a new program. WRITE DOWN THOSE PROGRAMS YOU WISH TO SAVE.

IMPORTANT: If you want to change the program without erasing it, see 5.41 Using the Edit Mode.

• Program Steps

A program can consist of any combination of Maxx's functions (moving, turning, speaking pre-programmed or user-programmed words and phrases, playing pre-programmed or user-programmed music, etc.). For example, he can be programmed to move, turn, speak, and play music in the same program. Each function you want Maxx to perform is entered as a program step.

Maxx can store up to 255 program steps, starting with step 000 and ending with step 254. When his program memory is full, his display will read "FULL", he will say "Sorry, my circuits are full" and he will return to the Immediate Mode. He will still execute the part of the program already accepted before he said "Sorry, my circuits are full."

NOTE: For each program step, you must press the desired command followed by a "parameter". A parameter is a number that allows you to indicate units (degrees or inches) of movement. These numbers are supplied within each of the separate programming functions in this section.

NOTE: If the number or numbers you enter are not acceptable (i.e., they are incorrect), Maxx will let you know by emitting a buzzing tone. Try again by re-entering both the command and the parameter.

Maxx's arm can be set to move into any one of approximately 130 positions, about 2.1 degrees at a time. In other words, one unit of movement up or down is equal to a 2.1 degree change. The number you enter, multiplied by 2.1 degrees, is the amount of the change.

• To Program Arm Movement:

1. Press the <PROGRAM> key to enter the Program Mode.
2. Press the <ARMS UP> or <ARMS DOWN> key.
3. The display will read "Au_" [arms up] or "Ad_" [arms down]. This is a PROMPT indicating that Maxx expects a number, from 0 to 99, specifying how much the arms should be moved. Each number is equal to a 2.1-degree unit of movement. Experiment with different numbers and observe how far the arms move.
4. After the number keys have been pressed, press the <ENTER> key to complete and store the program step.
5. The display will now show the number of the next program step, indicating that Maxx is ready for further programming.

NOTE: Since the maximum notation of any single move is limited to 99, a movement that requires a number higher than 99 will require two program steps, up to a total of 130.

• Here's A Program That Will Demonstrate Maxx's Arm Movement Abilities:

Preliminary Steps

1. Press the <POWER/STOP> key. This will activate Maxx. He will play his Immediate Mode tune and say "I'm ready."
2. Press the <PROGRAM> key. Maxx will play his Program Mode tune and say "Please program me."



PROGRAM STEP

4.21 PROGRAMMING ARM MOVEMENTS



PROMPT FOR ARM MOVEMENT UP



PROMPT FOR ARM MOVEMENT DOWN

4.21 PROGRAMMING ARM MOVEMENTS (CON'T)

- Step 000
 Command - Press the <HOME> key and the <ENTER> key.
 Operation - Maxx will move his arms, wrist and claw to their initial starting, or home, position when the program is executed.
- Step 001
 Command - Press the <ARMS UP> key. Then press the <1> key, the <0> and the <ENTER> key.
 Operation - Maxx will raise his arms when the program is executed.
- Step 002
 Command - Press the <ARMS DOWN> key. Then press the <5> key and the <ENTER> key.
 Operation - Maxx will lower his arms when the program is executed.
- Step 003
 Command - Press the <ARMS UP> key. Then press the <4> key, the <5> key and the <ENTER> key.
 Operation - Maxx will raise his arms when the program is executed.
- Step 004
 Command - Press the <ARMS DOWN> key. Then press the <2> key, the <0> key and the <ENTER> key.
 Operation - Maxx will lower his arms when the program is executed.
- EXECUTE
 Command - After the program is entered, press the <EXECUTE> key.
 Operation - Maxx will run through the operations you have just programmed.

4.22 PROGRAMMING WRIST MOVEMENTS

Maxx's wrist can be set to rotate in any one of approximately 169 positions, about 2.1 degrees at a time.

NOTE: Since the maximum notation of any single move is limited to 99, a movement that requires a number higher than 99 will require multiple program steps.

•To Program Wrist Movement:

1. Press the <PROGRAM> key to enter the Program Mode.
2. Press the <WRIST UP> or <WRIST DOWN> key.
3. The display will read "Uu__" [wrist up] or "Ud__" [wrist down]. This is a PROMPT indicating that Maxx expects a number, from 0 to 99, specifying how much the wrist should be moved. Experiment with different numbers and observe how far the wrist moves.
4. After the number keys have been pressed, press the <ENTER> key to complete and store the program step.
5. The display will now show the number of the next program step, indicating that Maxx is ready for further programming.

•Here's A Program That Will Demonstrate Maxx's Wrist Movement Abilities:

Preliminary Steps

1. Press the <POWER/STOP> key. This will activate Maxx. He will play his Immediate Mode tune and say "I'm ready."
2. Press the <PROGRAM> key. Maxx will play his Program Mode tune and say "Please program me."



PROMPT FOR WRIST
MOVEMENT UP



PROMPT FOR WRIST
MOVEMENT DOWN

- Step 000
Press the <HOME> key and the <ENTER> key. - Command
Maxx will move his arms, wrist and claw to their initial starting, or - Operation
home, position when the program is executed.
- Step 001
Press the <WRIST DOWN> key. Then press the <3> key, the <0> - Command
and the <ENTER> key. - Operation
Maxx will move his wrist down when the program is executed.
- Step 002
Press the <WRIST UP> key. Then Press the <2> key, <0> key - Command
and the <ENTER> key. - Operation
Maxx will move his wrist up when the program is executed.
- Step 003
Press the <WRIST DOWN> key. Then press the <6> key and the - Command
<ENTER> key. - Operation
Maxx will move his wrist down when the program is executed.
- Step 004
Press the <WRIST UP> key. Then press the <1> key and the - Command
<ENTER> key. - Operation
Maxx will move his wrist up when the program is executed.
- EXECUTE
Press the <EXECUTE> key. - Command
Maxx will run through the operations you have just programmed - Operation
him to perform.

The claw can also be programmed to rotate to any one of approximately 84 positions, about 4.2 degrees at a time.

4.23 PROGRAMMING CLAW MOVEMENT

•To Program The Claw To Rotate:

1. Press the <PROGRAM> key to enter the Program Mode.
2. Press the <CLAW ROTATE> key.
3. The display will read "Cr_". This is a PROMPT indicating that Maxx expects a number, from 0 to 84, specifying how much the claw should be rotated. Experiment with different numbers and observe how the claw rotates.
4. After the number keys have been pressed, press the <ENTER> key to complete and store the program step.
5. The display will now show the number of the next program step, indicating that Maxx is ready for further programming.

NOTE: The claw only rotates clockwise from Maxx's perspective.



PROMPT FOR CLAW ROTATION



PROMPT FOR CLAW MOVEMENT

•To Program The Claw To Close Or Open:

1. Press the <PROGRAM> key to enter the Program mode.
2. Press the <CLAW CLOSE/OPEN> key.
3. The display will read "Cco_". This is a PROMPT indicating that Maxx expects a number specifying whether the claw should be closed or opened.
4. Press the <0> key to program the claw to open fully.
5. Press the <1> key to program the claw to close fully.
6. After the number key has been pressed, press the <ENTER> key to complete and store the program step.
7. The display will now show the number of the next program step, indicating that Maxx is ready for further programming.

NOTE: The claw will fully close before it will open again, and vice versa (see 4.12A Moving Arms, Wrist and Claw).

•Here's A Program That Will Demonstrate Maxx's Claw Movement Abilities:

Preliminary Steps

1. Press the <POWER/STOP> key. This will activate Maxx. He will play his Immediate Mode tune and say "I'm ready."
2. Press the <PROGRAM> key. Maxx will play his Program Mode tune and say "Please program me."

Step 000

Command - Press the <HOME> key and the <ENTER> key.

Operation - Maxx will move his arms, wrist and claw to their initial starting, or home, position when the program is executed.

Step 001

Command - Press the <CLAW CLOSE/OPEN> key. Then press the <0> key and the <ENTER> key.

Operation - Maxx will open his claw when the program is executed.

Step 002

Command - Press the <CLAW ROTATE> key. Then press the <3> and the <ENTER> key.

Operation - Maxx will rotate his claw when the program is executed.

Step 003

Command - Press the <CLAW CLOSE/OPEN> key. Then press the <1> key and the <ENTER> key.

Operation - Maxx will close his claw when the program is executed.

Step 004

Command - Press the <CLAW ROTATE> key. Then press the <7> key and the <ENTER> key.

Operation - Maxx will rotate his claw when the program is executed.

EXECUTE

Command - Press the <EXECUTE> key.

Operation - Maxx will run through the operations you have just programmed.

4.24 PROGRAMMING BODY MOVEMENTS

Maxx can be programmed to move forward or in reverse.

•To Program Forward Or Reverse Movement:

1. Press the <PROGRAM> key to enter the Program Mode.
2. Press the <DRIVE FORWARD> or <DRIVE REVERSE> key.
3. The display will read "F____" [forward] or "b____" [reverse]. This is a PROMPT indicating that Maxx expects a number, from 0 to 255, specifying how many inches forward or backward he should move. The number or numbers you enter, multiplied by approximately one inch, will specify how far Maxx will move.
4. After the number keys have been pressed, press the <ENTER> key to complete and store the program step.
5. The display will now show the number of the next program step, indicating that Maxx is ready for further programming.

NOTE: When the program is executed, Maxx will move at his high speed. There is no shifting from the low to the high speed in the Program Mode.

•To Program A Left Or Right Turn:

1. Press the <PROGRAM> key to enter the Program Mode.
2. Press the <DRIVE LEFT> or <DRIVE RIGHT> key.



PROMPT FOR FORWARD
BODY MOVEMENT



PROMPT FOR REVERSE
BODY MOVEMENT

3. The display will read "L__" [drive left] or "r__" [drive right]. This is a PROMPT indicating that Maxx expects a number specifying how many inches to his left or right he should turn. The number or numbers you enter, multiplied by approximately one and one half inch, will specify how far Maxx will turn.

4. After the number keys have been pressed, press the <ENTER> key to store the program step.

5. The display will now show the number of the next program step, indicating that Maxx is ready for further programming.

• *Here's A Program That Will Demonstrate Maxx's Body Movement Abilities:*

Preliminary Steps

1. Press the <POWER/STOP> key. This will activate Maxx. He will play his Immediate Mode tune and say "I'm ready."

2. Press the <PROGRAM> key. Maxx will play his Program Mode tune and say "Please program me."



PROMPT FOR RIGHT TURN



PROMPT FOR LEFT TURN

Step 000

Press the <HOME> key and the <ENTER> key. - Command
Maxx will move his arms, wrist and claw into their initial starting, or - Operation
home, position when the program is executed.

Step 001

Press the <DRIVE FORWARD> key. Then press the <1> key, - Command
the <2> key and the <ENTER> key. - Operation
Maxx will move forward approximately 18 inches when the program - Operation
is executed.

Step 002

Press the <DRIVE RIGHT> key. Then press the <8> key and the - Command
<ENTER> key. - Operation
Maxx will move approximately 90 degrees to the right when the - Operation
program is executed.

Step 003

Press the <DRIVE BACKWARD> key. Then press the <6> key and - Command
the <ENTER> key. - Operation
Maxx will move back approximately 6-7 inches when the program is - Operation
executed.

Step 004

Press the <DRIVE LEFT> key. Then press the <8> key and the - Command
<ENTER> key. - Operation
Maxx will turn approximately 90 degrees to his left when the - Operation
program is executed.

EXECUTE

Press the <EXECUTE> key. - Command
Maxx will run through the operations you have just programmed. - Operation

Maxx's headlamp can be programmed to turn on or off. The headlamp is also used to play Moon Ball™ (see 4.5 GAME-PLAYING MODE).

• *To Program The Headlamp To Turn On Or Off:*

1. Press the <PROGRAM> key to enter the Program Mode.

2. Press the <LAMP> key.

3. The display will read "HL__".

This is a PROMPT indicating that Maxx expects a number, specifying whether the headlamp should be on or off.

4. Press the <1> key to program the headlamp to turn on.

**4.25 PROGRAMMING
THE HEADLAMP**



PROMPT FOR HEADLAMP

5. Press the <0> key to program the headlamp to turn off.
6. After the number key has been pressed, press the <ENTER> key to complete and store the program step.
7. The display will now show the number of the next program step, indicating that Maxx is ready for further programming.

4.26 PROGRAMMING A DELAY



PROMPT FOR
PROGRAM DELAY

A delay of 0 to 255 seconds between each program step can be programmed. This can be useful when you want Maxx to pause at any time during a program. The delay command should be used when programming Maxx to move first forward and then backward, and vice versa, so that he stops between a change in direction.

•To Program a Delay:

1. Press the <PROGRAM> key to enter the Program Mode.
2. Press the <NOTE REST/WAIT> key.
3. The display will read "d__". This is a PROMPT indicating that Maxx expects a number specifying how many seconds, up to a maximum of 255 seconds, you want the program to be delayed.
4. After the number keys have been pressed, press the <ENTER> key to complete and store the delay.
5. The display will now show the number of the next program step, indicating that Maxx is ready for further programming.

For example, to make the program delay 12 seconds, press the <NOTE REST/WAIT> key, the <1> key, the <2> key and the <ENTER> key.

NOTE: When Maxx is executing a program, and he reaches the program step that calls for a delay, his display will count down from the delay number entered to zero before going to the next program step.

4.27 CLEARING PROGRAM STEPS



CLEARING PROGRAM
STEP

Clearing a program step is useful if you make a mistake while entering a program.

IMPORTANT: After executing a program, never go back into the Program Mode to correct the program unless you are in the Edit Mode, or your program will be lost.

NOTE: To change a program without erasing it, see 5.4 PROGRAM EDITING.

•To Clear Program Steps While Programming:

1. Press the <CLEAR> key and hold for approx. 1 second.
2. The display will read "CLr_" for a short time.
3. The number of the current program step that has just been cleared will appear briefly in Maxx's display.
4. Each depression of the <CLEAR> key will clear the previous command.
5. Repeated depression of the <CLEAR> key will eventually clear the entire program, step by step. The display will indicate "bEg", showing that the program is at the beginning.



BEGINNING OF
PROGRAM

4.28 CLEARING AN ENTIRE PROGRAM



CLEARED PROGRAM

If you no longer want an entire program, it can be cleared from Maxx's memory.

•To Clear An Entire Program While in the Program Mode:

1. Press the <CLEAR> key.
2. The display will read "CLr".
3. Press the <PROGRAM> key.
4. Now the display will read "CLrP," showing that the entire program has been cleared. In other words, the entire program will be erased from Maxx's memory; it cannot be recalled and must be re-entered. As you have seen, in the Program Mode, the program is run by pressing the <EXECUTE> key (see 4.4 EXECUTE MODE).

4.29 RUNNING A PROGRAM

NOTE: If you do not want to run the program right away, use the <POWER/STOP> key after the whole program has been entered. This will return Maxx to the Immediate Mode and save the program as long as Maxx's POWER SWITCH is not turned off, and as long as you do not re-enter either the Program Mode or the Learn Mode.

NOTE: The program alternates between running forward and running backward. For example, if the program was just stored in the Program Mode, pressing the <EXECUTE> key will run the program forward. Pressing the <EXECUTE> key again will run the program backward. Pressing the <EXECUTE> key once more will run the program forward again, and so on.

This feature has been pre-set; however, it can be shut off so that the program will only run forward (see 5.6 FORWARD AND BACKWARD PROGRAM EXECUTION).

When you press the <LEARN> key, Maxx will play his Learn Mode tune and say "Please teach me."

4.3 LEARN MODE

In this mode you "teach" Maxx by actually running through a series of operations as if you are using the Immediate Mode. Maxx will respond by immediately performing each command you enter. In this way you will be able to watch him as he learns and monitor his responses. Pressing the <EXECUTE> key makes Maxx run the Learned program.

NOTE: Remember that the program currently in Maxx's memory will be cleared when you leave and then return to either the Program or Learn Modes. WRITE DOWN THOSE PROGRAMS YOU WISH TO SAVE.

If you want to return to the Program Mode or Learn Mode to change the program without erasing it, use the Edit Mode (see 5.4 PROGRAM EDITING).

As with the Program Mode, each step is entered one at a time. Maxx's motions, speech, music, etc. are recorded as programs that can be executed at a later time.

Pressing the <LEARN> key causes Maxx to record all the commands that follow as a program (up to 255 steps). Follow the same steps as you would in the Immediate Mode (see 4.1 IMMEDIATE MODE). Use the <EXECUTE> key to run the program Maxx has "learned" (see 4.4 EXECUTE MODE below). Use the <POWER/STOP> key to exit the Learn Mode.

IMPORTANT: After executing a program, never go back into the Program Mode or Learn Mode to correct the program unless you are in the Edit Mode, or your program will be lost. To change a program without erasing it, see 5.4 PROGRAM EDITING. However, returning to the Program or Learn Modes will not affect either songs or speech that you have programmed.

Like clearing program steps in the Program Mode, the <CLEAR> key can be used while programming to clear program steps in the Learn Mode (see 4.27 Clearing Program Steps). Each depression of the <CLEAR> key will clear the current step. If the <CLEAR> key is depressed repeatedly, the entire program will eventually be cleared, step by step, and the display will show "bEg". After clearing the steps you don't want, continue the program.

4.32 CLEARING A PROGRAM STEP

Like clearing an entire program in the Program Mode, an entire program can be cleared while you are in the Learn Mode by pressing

4.33 CLEARING AN ENTIRE PROGRAM

4.33 CLEARING AN ENTIRE PROGRAM

the <CLEAR> key and the <PROGRAM> key (see 4.28 Clearing an Entire Program).

4.4 EXECUTE MODE

In the Execute Mode, Maxx carries out a program which has been entered in the Program, Learn, Speech or Song Modes. He will play the Execute Mode tune before running the program. Each program step is displayed as Maxx performs it.

4.41 EXECUTING A PROGRAM

Pressing the <EXECUTE> key will make Maxx run a program that has been stored while in the Program or Learn Modes. While running the program, the display will show the number of the next program step.

NOTE: The program alternates between running forward and running backward. For example, if the program was just stored in the Program Mode, pressing the <EXECUTE> key will run the program forward. Pressing the <EXECUTE> key again will run the program backward. Pressing the <EXECUTE> key once more will run the program forward again, and so on.

IMPORTANT: IN THE LEARN MODE, IF THE PROGRAM HAS JUST BEEN LEARNED, THE FIRST TIME THE PROGRAM IS EXECUTED IT WILL RUN BACKWARD. Pressing the <EXECUTE> key a second time, after Maxx has run through the program backwards, will make the program run forward.

NOTE: This feature can be switched OFF so that you can only run the learned program forward (see 5.6 FORWARD AND BACKWARD PROGRAM EXECUTION).

NOTE: Since the claw can only rotate in one direction, when the program runs backwards, the claw will move ahead to the position where it would have stopped if it had rotated backwards.

4.42 STOPPING PROGRAM EXECUTION

Use the <POWER/STOP> key if Maxx is about to do something undesired. This will abort the execution of the program, stop Maxx, and return him to the Immediate Mode. You can also use the STOP button on his head. Press the <EXECUTE> key to continue. Maxx will resume at the next program step.

4.43 PAUSING DURING PROGRAM EXECUTION

The <WAIT> key can be used to make Maxx's program pause during execution. (To change steps in the program, follow the procedures outlined in 5.4 PROGRAM EDITING.) Press <ENTER> for Maxx to continue. He will resume at the next program step.

4.5 GAME-PLAYING MODE

Maxx is pre-programmed to play two different games. They are "Moon Ball"[™], Maxx's version of table tennis played with light, and "Force Field"[™], where you try to "zap" Maxx with "fire" from the controller as he momentarily drops his "Force Field."

Press the <GAME> key. Maxx will play his Game Mode tune and say "Please choose game."

To play Moon Ball, press the <0> key. To play Force Field, press the <1> key.

4.51 MOON BALL[™]

•How To Play MOON BALL (Game Choice <0>):

Object:

To score points using the mirror paddle, by reflecting Maxx's headlamp back to the PHOTO TRANSISTOR between his eyes (see Master Photo).

To Begin:

NOTE: You will need an area where Maxx can move freely left and right. You will also need a clear area with approximately a six foot radius around the front of Maxx.

1. Press the <GAME> key. Maxx will move his arms, wrist and claw to their initial (home) positions. Then he will say "Please choose game."
2. To play Moon Ball, press the <0> key and then the <ENTER> key. Maxx will say "please choose how tough."
3. Press the <0>, <1>, <2> or <3> key to select the level of difficulty. (Level <0> is the easiest; level <3> is the hardest.) Then press <ENTER>.
4. Remove and unfold the mirror paddle that is stored in Maxx's CHEST PANEL. Peel protective sheet from mirror.

To Play:

After you have pressed the key specifying the level of difficulty, Maxx's wrist will move down, his headlamp will turn on and he will say "Ready." Stay within 2' to 3' of the headlamp and use the mirror paddle to reflect the headlamp back to the PHOTO TRANSISTOR between Maxx's eyes. This signals that you are ready to play. If you do not reflect the light back within 20 seconds, Maxx will return to the Immediate Mode.

1. Maxx will begin by randomly moving right or left and playing a tune. Within a few seconds, his headlamp will flash briefly.
2. Play proceeds in a manner similar to table tennis. To score a successful return, you must reflect the light back between Maxx's eyes as soon as his headlamp comes on.
3. If you reflect the light back quickly enough, Maxx will say "good play" and add a point to your score. Your score will be shown on Maxx's display.
4. If you fail to reflect the light back soon enough, Maxx will buzz and no points will be scored.
5. After you miss three times, the game will end and Maxx will say "Game over." Maxx will then say "Choose enter to play again." If you do not press <ENTER> within 20 seconds, he will return to the Immediate Mode.

NOTE: The speed and difficulty of the game increase as the game proceeds. Maxx will allow less and less time for you to reflect back the light. He will also dodge back and forth in larger arcs. To compensate for this added difficulty, the number of points scored with each successful return will increase.

To Win:

When competing against others, the player with the highest score wins. Players do not take turns. Each player completes a game and makes note of his score.

When playing solo, keep track of your highest score and challenge your friends to beat it.

• *How to Play FORCE FIELD (Game Choice <1>):*

Object:

To score points by "zapping" Maxx with "laser fire" from the controller as he momentarily drops his "Force Field".

To Begin:

1. Press the <GAME> key. Maxx will say "Please choose game."
2. To play Force Field, press the <1> key and then the <ENTER> key. Maxx will say "Please choose how tough."
3. Press the <0>, <1>, <2> or <3> key to select the desired level of difficulty. (Level <0> is the easiest; level <3> is the hardest.) Then press <ENTER>.

4.52 FORCE FIELD™

4.52 FORCE FIELD™

As the level of difficulty increases, the action of the game speeds up, some of the sounds change and the "stun" time (see below) changes.

To Play:

Maxx's "shield" is indicated by a low-pitched siren. When his "shield" is down, Maxx can fire his "laser," which emits a warbling sound. His headlamp goes on to indicate he is firing his "laser."

Your "shield" is activated by pressing and holding the <0> key on the controller. Your "laser" is activated by pressing and holding the <3> key on the controller. The "laser" will emit a single, downward tone when used. The "shield" will make no sound. The "laser" can't fire when the "shield" is up.

•When Maxx's Shield Is Down:

1. Lower your "shield" by releasing the <0> key.
2. Fire your "laser." The "laser" will automatically fire for as long as the button is held down; however, it can be refired more quickly if the <3> key is repeatedly pressed.
3. Activate your "shield" as soon as you stop firing your "laser" by pressing the <0> key.

•Scoring:

1. One point is awarded each time you hit Maxx with "laser" fire while his "shield" is down.
2. Maxx cannot fire when his "shield" is up. You can shoot at Maxx's "shield", but he can't fire back. Also, there is a 1-in-4 chance that the shot will ricochet back off his shield and hit you. If this happens, a point is subtracted from your score.
3. You can also lose a point if you shoot while your own shield is up, regardless of what Maxx is doing.
4. If your "shield" is up when Maxx fires, the shot is harmlessly deflected. But if your shield is down, Maxx can score a hit. This will momentarily "stun" you so that you won't be able to fire the "laser" for a short while.
5. Maxx's score is shown on the right half of his display. Your score is shown on the left half of his display.

NOTE: The game progresses in levels, each one lasting approximately 20 seconds. Between levels, an intermission tune (consisting of random notes) is played, and the current level is displayed.

To Win:

The first to score 25 points (you or Maxx) wins the game.

4.6 OTHER OPERATING MODES

In addition to the five major modes, Maxx has several minor modes. They include:

1. Program Song Mode. In this mode, notes are programmed from the controller. You can recall the song or have it played automatically during a program.
2. Learn Song Mode. In this mode, Maxx learns the song as you play it on the controller.
3. Program Speech Mode. In this mode, sixteen sentences of up to fifteen words each can be programmed.

4.61 PROGRAM SONG MODE

Creating a program in the Song Mode is more complicated than just playing notes in the Immediate Mode. For each note, you must first enter the note pitch (the top twelve number keys on the controller) and the duration of the note as shown in the chart below. Once the song has been stored in Maxx's music memory, it can be executed during a program.

•To Program Songs:

1. Press the <PROGRAM> key. Maxx will play the program tune and the display will show "Prog".
2. Before the program tune ends, press the <SONG> key. Maxx's display will show "Song" and then program step "00__".
3. Press the key corresponding to the pitch of the note.
4. Press the key corresponding to the duration of the note (see chart below).
5. Maxx's display will indicate the note number, pitch and duration as this information is entered.
6. Press the <ENTER> key to complete and store the program step. The note of the chosen pitch and duration will play when the <ENTER> key is pressed.
7. Maxx's display will now show program step "01__", indicating that he is ready for the next note to be entered.

Enter the entire song by repeating this procedure. The notes that have been entered can be played at any time by pressing the <EXECUTE> key. This lets you check what you have entered so far. (See 4.14B Using the Controller as a Musical Instrument).









Also, this song can be inserted anywhere into a program (see 4.61 Playing a Programmed Song below).

IMPORTANT: Maxx's music memory can hold up to 127 notes. This corresponds to a maximum playing time of approximately 2 minutes if only whole notes are used. The playing time will be shorter if notes of shorter duration are used.

When Maxx's music memory is full, his display will read "FULL", he will say "Sorry, my circuits are full" and he will return to the Immediate Mode. Therefore, if your song is longer than 2 minutes, or 127 notes, only the first 2 minutes, or 127 notes, will be stored in Maxx's memory.

NOTE: After note number 99 has been entered, Maxx's display will read "00__", indicating note number 100. In other words, note numbers 100 to 127 will appear as numbers 00 to 27 in Maxx's display.

Enter the note's duration with the aid of the following chart:

Key	Note	Duration	Key	Note	Duration
1		whole	5		quarter
2		dotted half	6		dotted eighth
3		half	7		eighth
4		dotted quarter	8		sixteenth

•To Program A Rest:

1. Press the <NOTE REST/WAIT> key.
2. Reading from left to right, Maxx's display will show the program step, the duration, and the letter "r" followed by a blank. This is a PROMPT for you to enter the duration of the rest with one of the numbers, from 1 to 8, in the table listed above.
3. After the number keys have been pressed, press the <ENTER> key to complete and store the delay.
4. The display will now show the number of the next program step, indicating that Maxx is ready for further music programming.



PROGRAM STEP



NOTE (PITCH)



DURATION (QUARTER)

4.61A PROGRAMMING RESTS



PROMPT FOR REST

4.61B OCTAVE SHIFT

The music Maxx can play has a two-octave range; but since there is only one set of keys, a shift key is provided.

- *To Shift Octaves:*

1. Press the <OCTAVE> key before the note pitch is entered.
2. Each time the <OCTAVE> key is pressed, the octave switches up or down; therefore, if you raised the octave for the previous note and wish to go back to the lower octave, you must press the <OCTAVE> key again before pressing the next note key.
3. The upper octave is indicated by a decimal point (.) in the upper left-hand corner of Maxx's display.
4. Maxx will beep each time you press <OCTAVE>.

4.61C PLAYING A PROGRAMMED SONG

Song number 0 is a blank place for you to program your own song using the Program Song Mode. You can recall the song or have it executed automatically during a program.

- *To Play a Programmed Song:*

1. Press the <SONG> key. Maxx's display will show "Song" for a short time.
2. When Maxx's display shows "SN__", press the <0> key and the <ENTER> key. Maxx will now play your programmed song.
3. To have the programmed song executed as part of a program, you can insert the song number <0> as a program step when you are in the Program Mode or Learn Mode just as you would with pre-programmed songs (see 4.14A Programmed Songs).



PROMPT FOR PROGRAMMED SONG

4.61D CLEARING MISTAKES

Clearing individual notes is useful if you make a mistake while entering the program or when revising a program using the Edit Mode.

NOTE: More detailed editing procedures are possible (see 5.4 PROGRAM EDITING).

- *To Clear Individual Notes When in the Program Song Mode:*

1. Press the <CLEAR> key.
2. Maxx's display will read "Clr".
3. The number of the program step that has just been cleared will appear briefly in Maxx's display.
4. Each depression of the <CLEAR> key will clear the previous command.
5. Repeated depressions of the <CLEAR> key will eventually clear the entire programmed song, one note at a time.



CLEARED NOTED

4.61E CLEARING AN ENTIRE SONG

If you no longer want an entire song, it can be cleared from Maxx's memory as follows:

- *To Clear An Entire Song:*

1. Press the <POWER/STOP> key, then <PROGRAM>.
2. Before the Program tune ends, press <SONG>.

4.62 LEARN SONG MODE

As with the Program Song Mode, song number 0 is a blank place for you to teach Maxx your own song using the Learn Song Mode. You can recall the song or have it executed automatically during a program.

To Get Maxx To Learn A Song:

1. Press the <LEARN> key. Maxx will play the Learn Song tune and his display will show "LErn".

2. Before the learn tune ends, press the <SONG> key. Maxx's display will show "Song".
3. Enter the notes as you would in the Immediate Mode (see 4.14 Music). Maxx will then learn the song as you play it. Note pitches and durations will quickly flash on Maxx's display as you play.
4. Use the <POWER/STOP> key to exit the Learn Song Mode.

As with the Program Song Mode, Maxx's memory can hold up to 127 notes in the Learn Song Mode. This number is equal to a maximum playing time of approximately 2 minutes if only whole notes are used. If notes of a shorter duration are used, playing time will decrease. When Maxx's memory is full, his display will read "FULL", he will say "Sorry, my circuits are full" and he will automatically return to the Immediate Mode. Therefore, if your song is longer than 2 minutes, only the first 2 minutes of the song will be stored in Maxx's memory.

4.62A MAXX'S MUSIC MEMORY

See 4.14C or 4.61B Octave Shift.

4.62B OCTAVE SHIFT

•To Play A Learned Song:

1. Press the <SONG> key. Maxx's display will show "Song" for a short time.
2. When Maxx's display shows "Sn _", press the <0> key and the <ENTER> key. Maxx will now play your song.
3. To have the learned song executed as part of a program, you can insert the song number <0> as a program step when you are in the Program Mode or Learn Mode just as you would with pre-programmed songs (see 4.14A Programmed Songs).

4.62C PLAYING A LEARNED SONG

The first 16 places, numbered 0 through 15, are reserved in Maxx's memory for programming your own combination of words into phrases. Enter the words of each phrase using the controller in the sequence you want Maxx to speak them.

•To Program A Phrase:

1. Press the <PROGRAM> key. Maxx will play the Program tune and his display will show "Prog".
2. Before the program tune ends, press the <SPEECH> key. Maxx's display will read "PS__", indicating that he expects a number to be assigned to the phrase you are about to program.
3. Enter a number between 0 and 15. If you assign the same number to 2 phrases, the first phrase will be erased by the second.
4. After the number keys have been pressed, press the <ENTER> key.
5. Maxx's display will now show "S____". This is a PROMPT indicating that Maxx expects a number or numbers, specifying the first word you want him to learn. Press the number(s). Then press <ENTER>. Maxx will speak the word as you enter it.
6. Repeat step 5 until you have entered the words for the entire phrase. Then press the <POWER/STOP> key. After 15th word Maxx returns to Immediate Mode.

To have a programmed phrase executed as part of a program, you can insert the phrase number as a program step when you are in the Program Mode or the Learn Mode just as you would with pre-programmed phrases (see 4.13A Programmed Phrases).

4.63 PROGRAM SPEECH MODE



4.63A ENTERING PAUSES

While in the Program Speech Mode, press the <1> key, the <4> key and the <0> key in sequence to program a pause of approximately one second into the phrase you want Maxx to learn. Remember that each pause counts as a word. This will affect the total number of words (up to a maximum of 15 words) in each phrase.

4.63B CLEARING WORDS

While in the Program Speech Mode, pressing the <CLEAR> key allows you to clear words you do not want Maxx to learn. Press the <CLEAR> key each time you want to clear a word that is currently shown on Maxx's display.

5. ADVANCED FEATURES

Maxx has several advanced features. These include: Auto-Execute, Parallel Program Execution, Automatic Power-Down, Program Editing, Controllable Wrist/Arm Coupling, Forward and Backward Program Execution, and Verbal Prompts.

•Pre-Set Options:

The options listed below are pre-set. You may change these options for others described in this section.

1. Maxx's Auto-Execute feature will be OFF.
2. Maxx will be in the Serial Execution Mode.
3. His Automatic Power-Down feature will be ACTIVE.
4. His Controllable Wrist/Arm Coupling will be ACTIVE.
5. The Execute Program Backwards Mode will be ON.
6. Maxx's Verbal Prompts will be ACTIVE.

5.1 AUTO-EXECUTE



AUTO-EXECUTION ON



AUTO-EXECUTION OFF

Maxx can be set to automatically execute a program when the alarm goes off.

•To Set Auto-Execution:

1. Set the alarm (see 4.11B).
2. Press the <7> key and hold for approx. 1 second.
3. If the display shows "AEon", then the Auto-Execution Mode is active. Press the <POWER/STOP> key to exit this function.
4. If the display shows "AEoF", then the Auto-Execution Mode is off. Press the <7> key again to activate the Auto-Execution Mode.
5. The display will now show "AEon". Press the <POWER/STOP> key to exit this function.

NOTE: For Maxx to auto-execute, both the alarm and auto-execute must be on. Also, Maxx will only auto-execute if, at the time the alarm goes off, he is in the Immediate Mode or powered-down. For example, if Maxx is in the Program Mode, when the alarm goes off, he will simply play "Reveille" and will not auto-execute. To simply have Maxx sound his alarm without Auto-Execution, this feature can be shut off by going through steps 1 to 5 outlined above.

5.2 PARALLEL PROGRAM EXECUTION

Normally Maxx completes each program step before going on to the next. This is called Serial Program Execution. With the Parallel Program Execution Mode, Maxx goes to the next instruction before finishing the current instruction. This allows him to activate several functions at the same time. For example, Maxx can speak, play music, walk and move his arms and claw all at the same time. (Obviously, Maxx cannot perform contradictory commands, such as moving forward and backward at the same time.)

NOTE: Programming in the Parallel Program Mode is more complicated than in the Serial Mode. Sometimes you may not want to go on to the next instruction until Maxx has stopped. This is done by programming a delay.

•To Program A Delay:

1. In the Parallel Program Mode, whenever you want Maxx to finish all previous instructions before continuing, press the <NOTE REST/WAIT> key.
2. Press the number keys, corresponding to the number of seconds you want him to wait.
3. Then press the <ENTER> key.
4. If no actual time delay is desired, but you want Maxx to finish a step before going on to the next step, enter the program just as you would in the Program Mode and then program a delay of zero by pressing the <NOTE REST/WAIT> key, the <0> key and the <ENTER> key.

•*To Use The Parallel Program Execution Mode:*

1. Press the <CLOCK> key twice.
2. Maxx's display will read "StAt" [Status].
3. Press the <0> key and hold for approx. 1 second. Maxx's display will now read "PAr".
4. To keep the selection just seen on Maxx's display, return to the Immediate Mode by pressing the <POWER/STOP> key.
5. In the Parallel Program Mode, enter program commands as you would in the Serial Execution Mode. Press the <NOTE REST/WAIT> key if you want Maxx to finish a step before going on to the next step (see 5.2 above).

The Parallel Program Execution Mode will remain active until Maxx's power is shut off or you switch back to the Serial Execution Mode (see below).

NOTE: Run the parallel program by pressing the <EXECUTE> key.

5.21 STARTING A PARALLEL PROGRAM



PARALLEL PROGRAM EXECUTION

•*To Return Maxx To The Serial Execution Mode:*

1. Press the <CLOCK> key twice. Maxx's display will show "StAt" [Status].
2. Press the <0> key and hold for approx. 1 second.
3. Maxx's display will now read "SEr", indicating that he is in the Serial Execution Mode.

5.22 RETURNING TO THE SERIAL EXECUTION MODE



SERIAL EXECUTION MODE

After approximately 13 minutes of inactivity, Maxx automatically goes in the "Sleep" Mode. When Maxx begins his power shutdown procedure, he will play "Taps," then turn his power off. To turn him back on, press the STOP BUTTON on his head, then press the <POWER/STOP> key on the controller.

While Maxx is still playing "Taps," you can postpone his power shutdown by pressing any key. The tune will stop and Maxx's thirteen-minute timer will be reset.

5.3 POWER-DOWN

•*To Turn Off/On The Auto Power-Down Feature:*

1. Press the <CLOCK> key twice. Maxx's display will show "StAt" [Status].
2. Press the <1> key and hold for approx. 1 second.
3. If the display shows "PdoF" [Power-Down OFF], then the Auto Power-Down feature is off. Press the <1> key again to activate the Power-Down feature. Press the <POWER/STOP> key to exit this function.
4. If the display shows "Pdon" [Power-Down ON], then the Auto Power-Down feature is on. Press the <1> key again to turn off the Auto Power-Down feature.
5. Press the <POWER/STOP> key to exit this function.

5.31 AUTOMATIC POWER-DOWN



AUTO POWER DOWN OFF



AUTO POWER,DOWN ON

IMPORTANT: HEADLAMP MUST NOT BE LEFT ON WHEN MAXX GOES INTO HIS AUTO-POWER-DOWN MODE. ALWAYS SHUT OFF LAMP AFTER USING IT.

5.32 MANUAL POWER-DOWN

When you have finished a session with Maxx, you may not want to wait 13 minutes before Maxx goes into his Auto Power-Down procedure. Maxx can be set to Power-Down manually.

- *To Put Maxx Into The Power-Down Mode:*
 1. Press the <CLOCK> key twice. Maxx's display will show "StAt" [Status].
 2. Press the <6> key.
 3. Maxx will power down and go into the "Sleep" Mode. He can be awakened if the alarm goes off or if you push the STOP BUTTON on his head.

5.4 PROGRAM EDITING

When in the Program or Learn Modes, the program currently in Maxx's memory will be cleared when you re-enter the Program Mode or Learn Mode or enter a new program. However, by using the Edit Mode, program steps can be changed without erasing the program steps that are already there.

5.41 USING THE EDIT MODE



EDIT MODE ON DISPLAY



EDIT MODE OFF DISPLAY

- *To Use The Edit Mode:*
 1. Press the <CLOCK> key twice. Maxx's display will show "StAt" [Status].
 2. Press the <2> key and hold for approx. 1 second.
 3. If the display shows "Edon" [Edit ON], then the Edit Mode is on. Press the <2> key again to turn off the Edit Mode.
 4. If the display shows "EdoF" [Edit OFF], then the Edit Mode is off. Press the <2> key again to turn on the Edit Mode.
 5. Press the <POWER/STOP> key to exit this function.

With the Edit Mode on and in the Program Mode, pressing the <ENTER> key allows stepping forward through the program steps. The <BACKSTEP> key is used to move backwards through the program without erasing any program steps.

- *To Change A Program Step:*
 1. Press the <CLEAR> key to clear those steps not wanted.
 2. Enter a new command at that program step.
 3. When you are finished editing, press the <EXECUTE> key to run the program or press the <POWER/STOP> key to save the program.

5.42 PAUSING

In the Execute Mode, the <WAIT> key can be used to make Maxx's program pause. This is useful for program refinement. For example, suppose you programmed Maxx and, after running the program, found that the sequence of actions or responses isn't quite correct after step 10. Run the program again; but use the <WAIT> and <ENTER> keys to make Maxx pause at step 10. The corrections to the program can now be put in by using the Edit Mode (see 5.41 above).

- *To Pause During Program Execution:*
 1. Press the <WAIT> key and the program will stop at the end of the current command.
 2. Maxx's display will show the next command in the program. Enter the revised program step.
 3. Press the <ENTER> key to resume execution.

5.5 CONTROLLABLE WRIST/ARM COUPLING

When Maxx's arm moves, his wrist moves in the opposite direction, so he can lift an object and keep it level.

- *To Turn Off/On The Wrist/Arm Coupling:*

1. Press the <CLOCK> key twice. Maxx's display will show "StAt" [Status].
2. Press the <3> key and hold for approx. 1 second.
3. If the display shows "UCoF" [Coupling OFF], then the Wrist/Arm Coupling feature is off. Press the <3> key again to activate the Wrist/Arm Coupling feature.
4. If the display shows "UCoN" [Coupling ON], then the Wrist/Arm Coupling feature is on. Press the <3> key again to turn off the Wrist/Arm Coupling feature.
5. Press the <POWER/STOP> key to exit this function.

WRIST/ARM COUPLING
DISPLAY OFF

Maxx's program execution alternates between running forward and backward. This feature can be shut off so that Maxx will only run your stored program forward.

• *To Shut Off/Turn On The Execute Backwards Mode:*

1. Press the <CLOCK> key twice. Maxx's display will show "StAt" [Status].
2. Press the <4> key and hold for approx. 1 second.
3. If the display shows "EboF" [Execute Backward Off], then the Execute Backwards feature is off. Press the <4> key again to activate the Execute Backwards feature.
4. If the display shows "EboN" [Execute Backwards ON], then the Execute Backwards feature is on. Press the <4> key again to turn off the Execute Backwards feature.
5. Press the <POWER/STOP> key to exit this function.

5.6 FORWARD AND BACKWARD PROGRAM EXECUTION

EXECUTE BACKWARDS
MODE DISPLAY ONEXECUTE BACKWARDS
MODE DISPLAY OFF

Maxx will prompt during certain operations by saying things like "I'm ready" when entering the Immediate Mode, "Please teach me" when entering the Learn Mode, and "Please program me" when entering the Program Mode. While these prompts are helpful for the beginner, the experienced user may not want to hear them.

NOTE: Even if Maxx's verbal prompts are turned off, the pre-programmed music that "announces" each mode will still play.

• *To Turn Off/On Maxx's Verbal Prompts:*

1. Press the <CLOCK> key twice. Maxx's display will show "StAt" [Status].
2. Press the <5> key and hold for approx. 1 second.
3. If the display shows "SPoF" [Speech Prompt Off], then Maxx's Speech Prompts are off. Press the <5> key again to activate Maxx's Speech Prompts.
4. If the display shows "SPoN" [Speech Prompt ON], then Maxx's Speech Prompts are on. Press the <5> key again to turn off Maxx's Speech Prompts.
5. Press the <POWER/STOP> key to exit this function.

5.7 VERBAL PROMPTS

VERBAL PROMPT
DISPLAY ONVERBAL PROMPT
DISPLAY OFF

Maxx comes pre-set to maximum loudness. This can be adjusted by a volume control, located inside his chest storage compartment.

• *To Adjust Maxx's Volume:*

1. Open Maxx's CHEST PANEL DOOR.
2. Insert a non-conductive narrow flat blade, PLASTIC ALIGNMENT TOOL (available at most electronics stores) into the VOLUME CONTROL PORT in the center of Maxx's chest.

NOTE: DO NOT USE ANY METAL OBJECTS TO ADJUST THE VOLUME.

3. To lower the volume, carefully turn the alignment tool CLOCKWISE.
4. To raise the volume, carefully turn the alignment tool COUNTER-CLOCKWISE.

5.8 VOLUME ADJUSTMENT

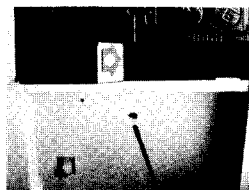

VOLUME CONTROL PORT

A. TECHNICAL DATA SPECIFICATIONS

BATTERY

Time between battery charge: 1½ to 4 hours, depending upon usage. Arms, wheels, wrist and claw use more current than speech and music. Battery Charge Time: approximately 14 hours, depending on conditions. (See LABEL on inside of Maxx's chest compartment.)

COMPUTER

Microprocessor: 65C02 (CMOS)

Internal Memory: 2K RAM (CMOS), 8K ROM

CONTROLLER

Keyboard: 25 multi-function keys

Battery Life of Controller: 20 hours

Range: approximately 25', depending on local conditions

Frequency: 27.095 Mhz

Power: 300mw

USER-PROGRAMMABLE MEMORY

Program Steps: 255

Music: 127 notes

Speech: 16 sentences of 15 words (maximum) each

Maximum Continuous Speech: 478 words

GENERAL INFORMATION

Base Vocabulary: approximately 140 words or word particles

Music Range: Two octaves (chromatic scale)

Serial Port on Controller

Expansion Interface Port on Maxx (in chest compartment)

Range of Operating Temperatures: 50° to 90° F.

B. GLOSSARY OF TECHNICAL TERMS

Edit: To change a step or steps in a program, such as clearing or inserting program steps.

Execute: To carry out or perform an instruction or series of instructions.

Initialize: To move Maxx to his initial starting (or Home) position.

K: Used to denote memory capacity of a computer in bytes; 1 K = 2¹⁰ bytes or 1024 in decimal notation.

Memory: The capacity to store and recall commands and information.

Mode: A way of doing something; a particular function.

Parameter: A number specifying increments (in degrees or inches) of movement.

Pre-Program: A set of step-by-step instructions that are permanently in Maxx's memory.

Prompt: A displayed indication that tells you a number is to be entered.

Program: (noun) A set of step-by-step instructions for Maxx to execute. (verb) To create a set of step-by-step instructions.

RAM: Random Access Memory; a memory containing data which can be read and modified. When you create a program or song or speech, it is stored in RAM.

ROM: Read-Only Memory; a memory containing data installed at the factory that can be read but not modified, such as Maxx's pre-programmed songs.

C. PRE-PROGRAMMED SONGS

Song number 0 is a blank place for you to program your own song (see 4.61 Program Song Mode and 4.62 Learn Song Mode). In addition, Maxx will play eight pre-programmed songs, numbered 1 to 8, under the conditions listed below or when you select them.

1. Immediate Mode tune. [When Maxx goes into the Immediate Mode or is reset when you press the STOP BUTTON on his head.]

2. Learn Mode tune. [When Maxx goes into the Learn Mode.]

3. Program Mode tune. [When Maxx goes into the Program Mode.]

4. Execute Mode tune. [When Maxx goes into the Execute Mode.]
5. Game Mode tune. [When Maxx goes into the Game-Playing Mode.]
6. Reveille. [When Maxx's alarm is activated.]
7. Power-Down tune. [When Maxx goes into the "Sleep" Mode.]
8. Taps. [When Maxx goes into the Auto Power-Down Mode.]

The first 16 places, numbered 0 through 15, are for programming your own combination of words into sentences. The following phrases, numbered 16 through 32, are the pre-programmed phrases Maxx can speak. Maxx will say these phrases under the conditions listed below, or when you select them.

16. "Hello. I am Maxx Steele." [When turned on.]
17. "Please choose game." [When Game Mode is entered.]
18. "Please choose how tough." [When game chosen has different levels of difficulty.]
19. "Good play." [When in Game Mode.]
20. "Thank you."
21. "Is there anything I can do for you?"
22. "Good morning."
23. "It is time to get up." [When using the Alarm Clock.]
24. "Maxx Steele wins." [If Maxx wins a game.]
25. "Congratulations. You win." [If you win a game.]
26. "I need energy. Please recharge me." [When power is running down.]
27. "Game over." [After win or lose statement.]
28. "Choose enter to play again." [After "Game over" statement.]
29. "Sorry my circuits are full." [When approaching program overload.]
30. "Please teach me." [When in the Learn Mode.]
31. "Please program me." [When in the Program Mode.]
32. "I'm ready." [When turned on, after statement #16.]

D. PRE-PROGRAMMED PHRASES

"AEon/AEof" [AUTO-EXECUTION]: Auto-Execution is on when LED display shows "AEon." It is off when the display shows, "AEof" (see 4.11C Auto-Execute).

E. GLOSSARY OF PROMPTS AND DISPLAY MESSAGES

"Au__" [ARM MOVEMENT]: Indicates that Maxx expects a number, specifying how much the arms should be moved (see 4.21 Programming Arm Movements).

"beg" [BEGINNING]: Indicates beginning of program (see 4.27 Clearing Program Steps).

"Cr__" [CLAW ROTATION]: Indicates that Maxx expects a number, specifying how much claw should be rotated (see 4.23).

"Cco_" [CLAW MOVEMENT]: Indicates Maxx expects a number indicating whether the claw should open or close (see 4.23 Programming Claw Movements).

". ." [PM INDICATOR]: When in the Clock Mode, the decimal point in the upper left of Maxx's display indicates PM when lit (see 4.11A Setting the Time).

E. GLOSSARY OF PROMPTS AND DISPLAY MESSAGES

"CLr_" [CLEARING A PROGRAM STEP]: Indicates the program step about to be cleared (see 4.27 and 4.61D Clearing Mistakes).

"CLrP" [CLEARED PROGRAM]: Shows that the entire program has been cleared (see 4.28 Clearing an Entire Program and 4.61E Clearing an Entire Song).

"d__" [PROGRAM DELAY]: Indicates that Maxx expects a number specifying how many seconds you want a particular program delayed (see 4.26 Programming a Delay).

"EboF"/"Ebon" [EXECUTE BACKWARDS MODE]: "Ebof" indicates that Maxx's Execute Backward Mode is OFF. "Ebon" indicates that Maxx's Execute Backward Mode is ON (see 5.6 FORWARD AND BACKWARD PROGRAM EXECUTION).

"Edon"/"EdoF" [EDIT MODE]: "Edon" indicates that Maxx's Edit Mode is ON. "EdoF" indicates that Maxx's Edit Mode is OFF (see 5.41 Using the Edit Mode).

"F__"/"b__" [BODY MOVEMENT]: Indicates how far forward or backward Maxx should move (see 4.24 Programming Body Movements).

"FULL" [PROGRAM MEMORY FULL]: Indicates that Maxx's memory is full (see 4.6 OTHER OPERATING MODES).

"HL_" [HEADLAMP ON/OFF]: Indicates that Maxx expects a number to turn on or off the headlamp (see 4.25 Programming the Headlamp).

"notE" [NOTE]: Indicates that Maxx is in the Note-Playing Mode (see 4.14 Music).

"PAr" [PARALLEL PROGRAM EXECUTION MODE]: Indicates that Parallel Program Execution Mode is active (see 5.21 Starting a Parallel Program).

"PdoF"/"Pdon" [AUTO POWER-DOWN]: "Pdof" indicates that Maxx's Auto Power-Down feature is OFF. "Pdon" indicates that Maxx's Auto Power-Down feature is ON (see 5.3 AUTOMATIC POWER-DOWN).

"PS__" [PROGRAM SPEECH MODE]: Indicates that Maxx expects a number corresponding to the sentence you want him to speak (see 4.63 Program Speech Mode).

E. GLOSSARY OF PROMPTS AND DISPLAY MESSAGES

"000" - "254" [PROGRAM STEPS]: While entering a program, the display indicates the current program step (see 4.2 PROGRAM MODE).

F. SPEECH CODES

NOTE: You may want to enlarge Maxx's vocabulary by putting words together to form new words. For example, if you press the <1> key, the <4> key, the <1> key and the <5> key, Maxx will respond by saying, "Fifteen" [words 14 (fif) and 15 (teen)]. See how many new words you can create by combining other words on this list.

SPEECH CODES:

0. zero	36. but	72. indicate	108. sorry
1. one	37. by	73. ing	109. sss
2. two	38. can	74. is	110. steele
3. three	39. charge	75. it	111. suppose
4. four	40. choice	76. just	112. sure
5. five	41. choose	77. lay	113. teach
6. six	42. circuits	78. let	114. test
7. seven	43. clear	79. liked	115. thank
8. eight	44. congratulations	80. load	116. that
9. nine	45. corded	81. long	117. the
10. ten	46. day	82. made	118. there
11. eleven	47. dead	83. match	119. thing
12. twelve	48. different	84. max	120. time
13. thir	49. do	85. me	121. tough
14. fif	50. ear	86. morn	122. try
15. teen	51. easy	87. my	123. turn
16. twen	52. energy	88. name	124. up
17. ty	53. enter	89. need	125. upper
18. hundred	54. error	90. no	126. wait
19. a	55. est	91. now	127. was
20. accepted	56. function	92. ok	128. way
21. again	57. full	93. opponent	129. were
22. ah	58. game	94. or	130. what
23. aid	59. get	95. out	131. when
24. aim	60. goes	96. over	132. who
25. am	61. good	97. ow	133. whoops
26. an	62. great	98. pal	134. will
27. and	63. hahahahaha	99. play	135. win
28. any	64. have	100. please	136. would
29. approach	65. hello	101. program	137. yes
30. are	66. how	102. proper	138. you
31. awe	67. human	103. re	139. zz
32. be	68. I	104. ready	140. [pause]
33. begin	69. if	105. run	
34. boost	70. I'm	106. serve	
35. bout	71. in	107. some	

IMPORTANT: TURN OFF POWER SWITCH BEFORE PERFORMING ANY MAINTENANCE

BULB REPLACEMENT

•To Replace Maxx's Chest Lights:

1. With arms in "home" position, remove any cartridges that may be in Maxx's CARTRIDGE/EXPANSION SLOT.
2. Press down at top ends of CHEST PANEL and snap out.
3. Unscrew faulty BULB(S) and replace with new 6v, 0.1 amp bulb, commonly available as bicycle tail lamp.
4. Replace CHEST PANEL by hooking in bottom of PANEL first and then snapping top into place.

•To Replace Maxx's Headlamp:

1. Remove HEADLAMP ASSEMBLY by "pinching" top and bottom between thumb and forefinger. Snap out.
2. Turn locking TAB clockwise and remove.
3. Remove and replace faulty BULB [#PR 12].
4. Replace TAB and lock into position by turning counter-clockwise.
5. Replace HEADLAMP ASSEMBLY by "pinching" top and bottom between thumb and forefinger. Put bottom of unit in first, then snap in top.

CLEANING

Maxx must be periodically inspected for dust and fibers on his wheel axles and in areas where moving parts are exposed.

•To Clean Maxx's Wheels:

1. With arms in "Home" position, put Maxx into the "Sleep Mode" by pressing the <CLOCK> key twice and then pressing the <6> key.
2. Carefully lay Maxx on his back.
3. Remove dust, dirt and fibers from around WHEELS. Make sure the rubber treads are centered on wheels.
4. Remove MEASURING WHEEL, located in center of base, by snapping out of plastic GROOVES.
5. Carefully inspect both sides of 4 MAGNETS, located inside MEASURING WHEEL and remove any dust, dirt or pieces of metal.
6. Replace MEASURING WHEEL exactly as removed by snapping back into GROOVES. Spin wheel to make sure it moves freely.

CHANGING CRYSTALS

NOTE: If more than one Maxx is being operated at the same time in the same location, it is necessary to use different sets of crystals (available at most electronics and hobby stores) in the controller (transmitter) and in Maxx (receiver). This is to avoid "jamming" the signals.

Listed below are all of the frequencies and the identification colors which can be used with Maxx. The set of crystals that have been put into the controller and Maxx at the factory is marked with an asterisk (*). When changing crystals, make sure that both come from the same set (i.e., with the same frequency and identification color) and that the crystal marked Tx is placed in the transmitter (controller) and the crystal marked Rx is placed in the receiver (Maxx).

MHz

26.995
27.045
27.095*
27.145
27.195

FLAG

Brown
Red
Orange*
Yellow
Green

G. ROUTINE MAINTENANCE

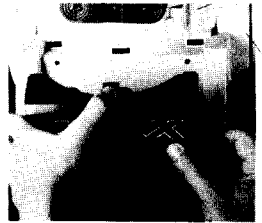

CHEST PANEL

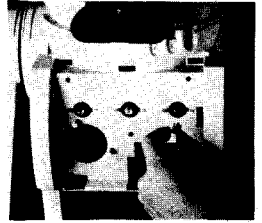

BULB REPLACEMENT



HEADLAMP ASSEMBLY

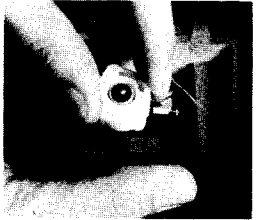

HEADLAMP BULB

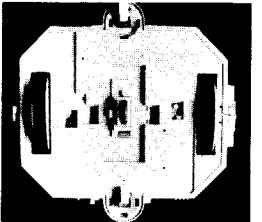

UNDERSIDE

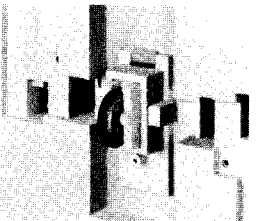

MEASURING WHEEL

G. ROUTINE MAINTENANCE

- *To Change The Crystal In The Controller:*
 1. Insert a small coin into the notch at the bottom of the battery cover on the back of the controller and snap out the BATTERY DOOR.
 2. Use a tweezers to remove the existing CRYSTAL, located directly below the BATTERY. Pull gently to remove.
 3. Insert the replacement CRYSTAL.
 4. Snap the BATTERY DOOR back into place.
- *To Change The Crystal In Maxx:*
 1. Open Maxx's SERVING TRAY DOOR.
 2. Remove the existing CRYSTAL, located in a SLOT in the lower right corner.
 3. Insert the replacement CRYSTAL.
 4. Close the SERVING TRAY DOOR.

FUSE REPLACEMENT

- *To Replace Maxx's Fuse:*
 1. Open Maxx's SERVING TRAY DOOR and pull off battery ACCESS COVER.
 2. Push in and twist open the PLASTIC HOUSING that encases the FUSE on the red lead from the positive side of the BATTERY.
 3. Remove and replace faulty FUSE with new #3AG, 5 amp. fast blow fuse or equivalent (available at most electronics stores).

IMPORTANT: Replace the fuse only with the exact same rating. Using a fuse of a higher rating may damage Maxx and invalidate the warranty.

 4. Push in and twist close the PLASTIC HOUSING. Replace ACCESS COVER.
 5. Close SERVING TRAY DOOR.



EYES

H. NORMAL OPERATING CONDITIONS

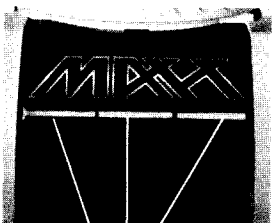

CHEST LIGHTS

The following actions will always occur under the conditions listed below:

1. Maxx's EYES are constantly lit when he is active.
2. Whenever Maxx is speaking or playing music, his 3 CHEST LIGHTS will scan.
3. After approximately 13 minutes of inactivity, Maxx automatically goes in the "Sleep" Mode. This power shutdown feature can be turned off (see 5.3 AUTOMATIC POWER DOWN).
4. The controller will remain on for approximately 60 seconds after the last keystroke and then shut off if no other buttons are pressed. To re-activate the controller, press the <POWER/STOP> key (see 2.4 STARTING MAXX).

I. CAUTIONS

NOTE: MAXX STEEL IS INTENDED FOR USE INDOORS. As with any electronic device, Maxx should be protected from dust, dirt and water. In addition, he "walks" best on flat, smooth surfaces. Thick-pile carpets will make it hard for Maxx to move, and the carpet threads can get caught in his wheels (see APPENDIX G. ROUTINE MAINTENANCE). **IMPORTANT:** Do not have Maxx's Claw carry objects whose weight is near maximum (12 oz.) with his arms extended out front. This will make him unstable and liable to tip over. Maxx can carry a light weight tray with his arms parallel to the ground, and objects, such as soda cans, close to his chest.

Maxx must be periodically inspected for dust and fibers on his wheel axles and in areas where moving parts are exposed. Make sure that Maxx's magnetic measuring wheel, located in the center of his

undercarriage, is free from metallic debris such as paper clips and metal staples (see APPENDIX G. ROUTINE MAINTENANCE).

Even though Maxx's motors are protected against overloads, care should be taken to avoid putting unnecessary strain on the motors. Do not overload the arm by giving it too heavy an object to lift or carry. Transporting any excess tray or claw weight (12 ounce maximum for the claw) will cause the protective emergency clutches in Maxx's arm to operate, producing a loud clicking, or "ratcheting," sound. (This does not damage the mechanisms.)

NOTE: If overloaded, Maxx will return to the Immediate Mode and stop all motors. If his wheels are turning, his display will read "Stal" (stall) and he will play a tone, indicating that his motors are not operating correctly. If this happens, press the <STOP> button on Maxx's head and then press the <HOME> key to return Maxx's arms, wrist and claw to their initial, or home, starting position.

Also, Maxx should not be allowed to push against immovable objects such as a wall or couch. This could strain his walking motors.

It is also important to keep Maxx off uneven surfaces where he is liable to tip or fall. IN AN EMERGENCY, the <POWER/STOP> key or the STOP BUTTON on Maxx's head should be used to stop any motors from running. Using these buttons will not clear any program that may be stored in his memory.

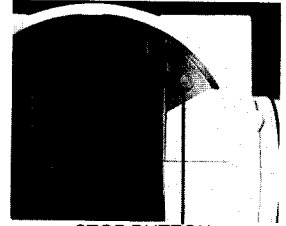

STOP BUTTON

This section deals with the controller and shows you how to use it to enter the commands you want Maxx to perform. Each function is cross-referenced to the appropriate sections of this guide.

Key 0: Drive Left/Musical Note C (see 4.12C Turning, 4.24 Programming Body Movements, 4.14 Music, 4.61 Program Song Mode and 4.62 Learn Song Mode)

Key 1: Drive Forward/Musical Note C# (see 4.12B Moving Forward and Backward, 4.24, 4.14, 4.61 and 4.62)

Key 2: Drive Reverse/Musical Note D (see 4.12B, 4.24, 4.14, 4.61 and 4.62)

Key 3: Drive Right/Musical Note D# (see 4.12C, 4.24, 4.14, 4.61 and 4.62)

Key 4: Wrist Up/Musical Note E (see 4.12A Moving Arms, Wrist and Claw, 4.22 Programming Wrist Movements, 4.14, 4.61, and 4.62)

Key 5: Wrist Down/Musical Note F (see 4.12A, 4.22, 4.14, 4.61 and 4.62)

Key 6: Arms Up/Musical Note F# (see 4.12A, 4.21 Programming Arm Movements, 4.14, 4.61 and 4.62)

Key 7: Arms Down/Musical Note G (see 4.12A, 4.21, 4.14, 4.61 and 4.62)

Key 8: Claw Rotate/Musical Note G# (see 4.12A, 4.23 Programming Claw Movements, 4.14, 4.61 and 4.62)

Key 9: Claw Close or Open/Musical Note A (see 4.12A, 4.14, 4.23, 4.61 and 4.62)

Key : Lamp On or Off/Musical Note A# (see 4.25 Programming the Headlamp, 4.14, 4.61 and 4.62)

Key : Home/Musical Note B (see 4.12 Motion, 4.14, 4.61 and 4.62)

Key : Wait or Note Rest (see 4.14B Using the Controller as a Musical Instrument, 4.26 Programming a Delay, and 4.43 Pausing During Program Execution)

Key : Shift Octave (see 4.14C Octave Shift and 4.61B Octave Shift)

J. SUMMARY OF CONTROLLER FUNCTIONS AND SPECIAL KEYS

J. SUMMARY OF CONTROLLER FUNCTIONS AND SPECIAL KEYS

- Key : Clear (see 4.32 Clearing a Program Step and 4.33 Clearing an Entire Program)
- Key : Enter (see 4.1 IMMEDIATE MODE, 4.2 PROGRAM MODE, 4.3 LEARN MODE, 4.4 EXECUTE MODE, 4.5 GAME-PLAYING MODE, 4.6 OTHER OPERATING MODES and 5. ADVANCED FEATURES)
- Key : Song or Notes (see 4.14, 4.61, and 4.62 Learn Song Mode)
- Key : Clock or Status (4.11 and 5. ADVANCED FEATURES)
- Key : Speech (see 4.13 Speech and 4.63 Program Speech Mode)
- Key : Back Step (see 5.4 PROGRAM EDITING)
- Key : Game (see 4.5 GAME-PLAYING MODE)
- Key : Program (see 4.2 PROGRAM MODE)
- Key : Learn (see 4.3 LEARN MODE)
- Key : Execute (see 4.4 EXECUTE MODE)
- Keybar: Power/Stop (see. I. CAUTIONS)

Special Keys:

The <POWER/STOP> key is used to return Maxx to the Immediate Mode and stop any motors that may be running. You can also use the STOP BUTTON on Maxx's head. Both of these keys are useful as "panic" buttons and to exit the Program, Learn, Execute and Game Modes.

The <CLEAR> key is used in the Program and Learn Modes to delete only the previous command from memory. Pressing the <CLEAR> key and then pressing the <PROGRAM> key will erase the entire program when you are in the Program Mode or Learn Mode (see 4.27 Clearing Program Steps and 4.28 Clearing An Entire Program).

The <ENTER> key is pressed to indicate the end of the command codes entered. For example, to play pre-programmed song number one, press <SONG>, <1>, <ENTER>. To get Maxx to speak phrase 20, press <SPEECH>, <2>, <0>, <ENTER>.

Pressing the <HOME> key causes Maxx to move to his initial starting position.

While some keys may have a single purpose, others can be used for more than one operation. For example, the <WAIT> key also functions as the <NOTE REST> key when in the music mode (see 4.14B Using the Controller as a Musical Instrument, 4.26 Programming a Delay, and 4.43 Pausing During Program Execution). The <SONG> key also functions as the <NOTE> key (see 4.14 Music, 4.61 Program Song Mode and 4.62 Learn Song Mode). In the same manner, the <CLOCK/STATUS> key can either be used for setting the clock or for using Maxx's advanced features (see 4.11 Time and 5. ADVANCED FEATURES).

The LED display panel at the top of Maxx's head will show you the commands or program instructions that have been given to Maxx. The LED display will also show the number of the next program step to be entered.

K. F.C.C. WARNING ON CLASS B PRODUCTS

This equipment generates and uses radio frequency energy and if not used properly, that is, in strict accordance with the manufacturer's instructions, may cause interference to radio and television reception. It has been verified and found to comply with the limits for a Class B computing device in accordance with the specifications in Subpart J of Part 15 of F.C.C. Rules, which are designed to provide reasonable protection against such interference in a residential installation.

However, there is no guarantee that interference will not occur in a particular installation. If this equipment does cause interference to radio or television reception, which can be determined by turning the robot off and on, the user is encouraged to try to correct the interference by one or more of the following measures:

- Reorient the receiving antenna on the radio or TV receiving interference.
- Move the robot away from the receiver.
- Plug the charger into a different outlet so that the robot and receiver are on different branch circuits.

If necessary, the user should consult the dealer or an experienced radio/television technician for additional suggestions. The user may find the following booklet prepared by the Federal Communications Commission helpful:

"How to Identify and Resolve Radio/TV Interference Problems"

This booklet is available from the U.S. Government Printing Office, Washington, DC 20402. Stock No. 004-000-00345-4.

**L. CONTENTS OF
THIS MANUAL**

NOTE: Decimal notation is used in this manual, rather than conventional page notation. This is designed to show you the main topic as well as each specific sub-topic at a glance.

1. INTRODUCTION**2. SETUP****2.1 UNPACKING****2.2 ACTIVATING MAXX'S POWER****2.3 CHARGING MAXX****2.4 THE CONTROLLER****3. STARTING MAXX****4. MODES OF OPERATION****4.1 IMMEDIATE MODE****4.11 Time****4.11A Setting the Time****4.11B Setting the Alarm****4.12 Motion****4.12A Moving Arms, Wrist and Claw****4.12B Moving Forward and Backward****4.12C Turning****4.13 Speech****4.13A Programmed Phrases****4.13B Pre-Programmed Words****4.14 Music****4.14A Programmed Song****4.14B Using the Controller as a Musical Instrument****4.14C Octave Shift****4.2 PROGRAM MODE****4.21 Programming Arm Movements****4.22 Programming Wrist Movements****4.23 Programming Claw Movements****4.24 Programming Body Movements****4.25 Programming the Headlamp****4.26 Programming a Delay****4.27 Clearing Program Steps****4.28 Clearing an Entire Program****4.29 Running a Program****4.3 LEARN MODE****4.31 Using the Learn Mode****4.32 Clearing a Program Step****4.33 Clearing an Entire Program****4.4 EXECUTE MODE****4.41 Executing a Program****4.42 Stopping Program Execution****4.43 Pausing During Program Execution****4.5 GAME-PLAYING MODE****4.51 Moon Ball™****4.52 Force Field™**

4.6 OTHER OPERATING MODES**4.61 Program Song Mode****4.61A Programming Rests****4.61B Octave Shift****4.61C Playing a Programmed Song****4.61D Clearing Mistakes****4.61E Clearing an Entire Song****4.62 Learn Song Mode****4.62A Maxx's Music Memory****4.62B Octave Shift****4.62C Playing a Learned Song****4.63 Program Speech Mode****4.63A Entering Pauses****4.63B Clearing Words****5. ADVANCED FEATURES****5.1 AUTO-EXECUTE****5.2 PARALLEL PROGRAM EXECUTION****5.21 Starting a Parallel Program****5.22 Returning to the Serial Execution Mode****5.3 POWER-DOWN****5.31 Automatic Power-Down****5.32 Manual Power-Down****5.4 PROGRAM EDITING****5.41 Using the Edit Mode****5.42 Pausing****5.5 CONTROLLABLE WRIST/ARM COUPLING****5.6 FORWARD AND BACKWARD PROGRAM EXECUTION****5.7 VERBAL PROMPTS****5.8 VOLUME ADJUSTMENT****A. TECHNICAL DATA/SPECIFICATIONS****B. GLOSSARY OF TECHNICAL TERMS****C. PRE-PROGRAMMED SONGS****D. PRE-PROGRAMMED PHRASES****E. GLOSSARY OF PROMPTS AND DISPLAY MESSAGES****F. SPEECH CODES****G. ROUTINE MAINTENANCE****H. NORMAL OPERATING CONDITIONS****I. CAUTIONS****J. SUMMARY OF CONTROLLER FUNCTIONS AND SPECIAL KEYS****K. F.C.C. WARNINGS ON CLASS B PRODUCTS****L. CONTENTS OF THIS MANUAL**